



# Access Link™

Instructional Audio System



User Manual





# Table of Contents

## OVERVIEW

- 3** Important Safety Instructions
- 5** System Components and Unpacking
- 6** Optional Components
- 7** Front Panel Controls and Indicators
- 8** Rear Panel Controls and Connections
- 9** Flexmike Controls and Connections
- 10** Microphone Cradle Charger

## SET-UP & OPERATION

- 11** Determine Set-Up Location
- 12** Connect Access Link to Amplifier
- 14** Audio Integration
- 15** Setting Up the Flexmike
- 16** Charging the Flexmike
- 17** Daily Use of the Flexmike
- 18** Using Your Microphone as a Wireless Audio Link

## OPTIONAL ACCESSORIES

- 19** Sharemike Controls and Connections
- 22** Media Connector Controls and Indicators
- 24** Using the Media Connector

## MAINTENANCE & TROUBLESHOOTING

- 27** Flexmike Battery Replacement
- 28** Sharemike Battery Replacement
- 29** Troubleshooting

## WARRANTY, SAFETY & SPECIFICATIONS

- 30** Five-Year Limited Warranty
- 31** Safety Warnings and Certifications
- 35** System Specifications



## OVERVIEW

# Important Safety Instructions

1. Do not use the apparatus near water.
2. Clean only with dry cloth.
3. Do not block any ventilation openings.
4. Do not install near any heat sources such as radiators, heat registers, stoves, or other apparatus (including amplifiers) that produce heat.
5. Do not defeat the safety purpose of the polarized or grounding-type plug. A polarized plug has two blades with one wider than the other. A grounding-type plug has two blades and a third grounding prong. The wide blade or the third prong is provided for your safety. If the provided plug does not fit into your outlet, consult an electrician for replacement of the outlet.
6. Protect the power cord from being walked on or pinched particularly at plugs, convenience receptacles, and the point where they exit from the apparatus.
7. Unplug this apparatus during lightning storms or when unused for long periods of time.
8. Refer all servicing to qualified service personnel. Servicing is required when the apparatus has been damaged in any way, such as power-supply cord or plug is damaged, liquid has been spilled or objects have fallen into the apparatus, the apparatus has been exposed to rain or moisture, does not operate normally, or has been dropped.
9. When the mains plug or appliance coupler is used as the disconnect device, it shall remain readily operable.
10. Please keep the unit in a good ventilation environment.
11. **WARNING:** To reduce the risk of fire or electric shock, do not expose this apparatus to rain or moisture.
12. Apparatus shall not be exposed to dripping or splashing and no objects filled with liquids, such as vases, shall be placed on the apparatus.
13. **WARNING:** Battery pack shall not be exposed to excessive heat such as sunshine, fire or the like. (1) The battery pack is not serviceable. Do not open, disassemble, or service any battery pack. (2) Do not crush or cut or puncture the internal battery cell. (3) Do not short-circuit the battery, or expose it to water or other liquids. (4) Do not touch the internal battery cell for any reason. (5) Keep the battery away from fire or a hot oven. Do not dispose of the battery into fire or a hot oven. (6) Keep the product with battery away from extremely low air pressure or high temperature surrounding environment. Battery subjected to extremely low air pressure may result in an explosion or the leakage of flammable liquid or gas. (7) Stop using the battery pack if it is damaged, or if you notice any discharge or the buildup of foreign materials on the battery contacts. (8) Do not put the battery in trash that is disposed of in landfills. When disposing of the battery pack, comply with local ordinances or regulations.
14. **CAUTION:** Risk of explosion if battery is replaced by any battery other than Lightspeed Part # L3.7V



## OVERVIEW

# System Components and Unpacking

The standard configuration of Access Link includes:

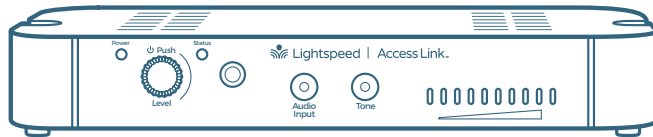

### Access Link

Instructional Audio System and Power Supply



### Flexmike

Teacher Microphone

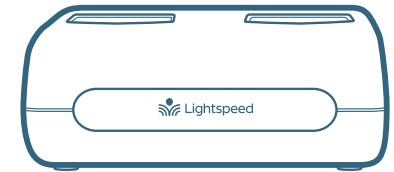

### Microphone Cradle Charger

and Power Supply



**NOTE ON PAIRING:** Access Link and any wireless components (microphones, Activate Station, Media Connector) are pre-paired at the Lightspeed factory as required for proper operation. If paired components are separated and swapped during the installation process, they must be re-paired.



# Optional Components

Optional equipment which may be part of your Access Link system



**Media Connector**  
and Power Adapter



**ShareMike**  
Student Microphone

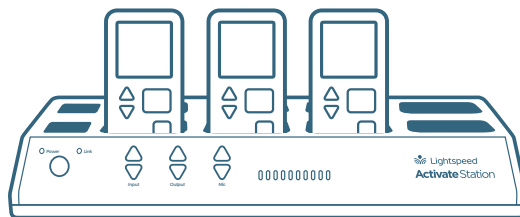

## Activate System

Group Learning Pods

*For further information on Activate,  
please visit [www.lightspeed-tek.com](http://www.lightspeed-tek.com)*



# Front Panel Controls and Indicators

1. **POWER LIGHT:** This light will turn white when power is on.
2. **POWER BUTTON:** Press and hold this push button to turn the system power on or off and adjust volume or tone.
3. **STATUS LIGHT:** Microphone link and pairing indicators  
**Solid white:** indicates an audio link has been established.  
**Flashing white:** indicates registration is in process.
4. **AUDIO INPUT VOLUME SELECTOR:** Selects Volume as the mode for the adjustment knob (2) for the audio sources connected to the audio inputs on the back of Access Link.
5. **tone SELECTOR:** Selects Tone as the mode for the adjustment knob (call out #2 below) for the microphone. This adjusts the bass or treble that is heard through the classroom speaker.

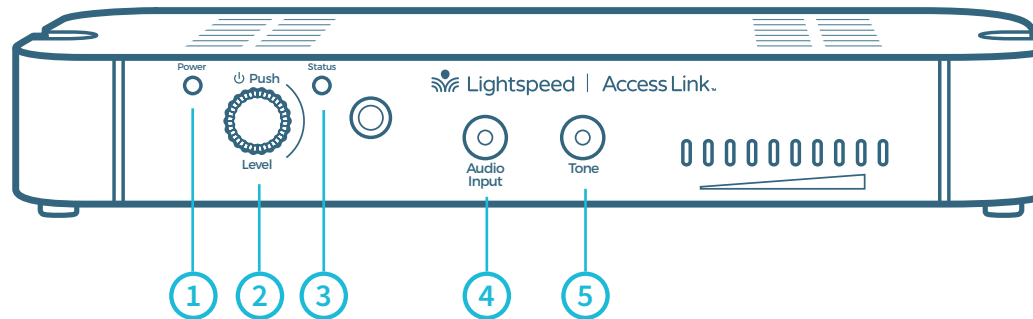



# Rear Panel Controls and Connections

1. **AUDIO INPUT:** 3.5mm stereo connector for connecting classroom audio sources to be played through audio system. One optical input is also available.
2. **UNBALANCED AUDIO OUTPUT:** This output sends the audio from Access Link to an input on an amplifier (Recommended for most applications).
3. **MIC/LINE LEVEL SWITCH:** Changes the audio output level from low (Mic level) to high (LINE level). Desired position depends on the input level of the amplifier.
4. **BALANCED AUDIO OUTPUT:** This output sends the audio from Access Link to a balanced input on an amplifier. (Recommended for longer cable runs connected to a balanced input).
5. **USB POWER INPUT:** Plug the micro-USB end of the power cable into this USB port.

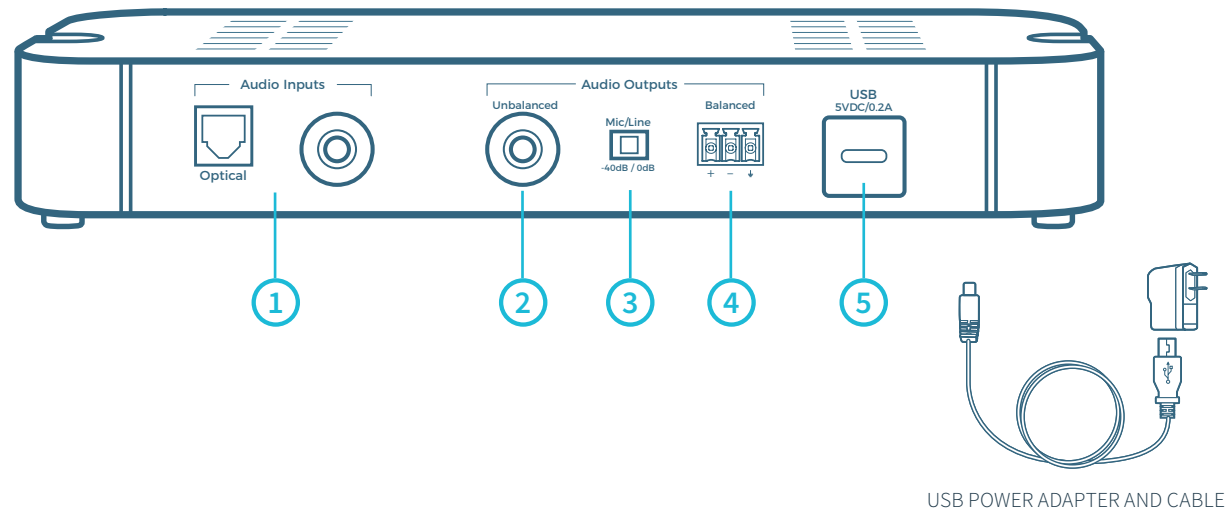



# Flexmike Controls and Connections

- POWER/MUTE SWITCH:** Press and hold to power on, press to mute, press and hold to power off.  
**Blue light:** Talk  
**White light:** Mute
- IR TRANSMITTER:** For pairing to base unit.
- MIC 1 STATUS:** lighted to indicate microphone is registered as Mic 1  
**White: solid** = Normal operation  
**White: flashing** = Linking in progress
- MIC 2 STATUS:** When using a second microphone, this LED is lighted to indicate microphone is registered as Mic 2  
**White: solid** = Normal operation  
**White: flashing** = Linking in progress
- MICROPHONE VOLUME UP/DOWN**
- POWER STATUS LIGHT**  
**Red light:** In operation, turns red to indicate low battery.  
**White light:** Normal operation  
  
When charging in Cradle Charger:  
**Red light:** Charging  
**Green light:** Charging complete
- EARBUD/MIC CONNECTION:** Connect the earbud for monitoring for use with Pods only, also for use with optional EMA (earset) and LMA (lapel) microphones.
- LANYARD INTERFACE:** Insert the lanyard into this hook to wear the Flexmike.
- BATTERY:** Remove the battery to replace the rechargeable battery pack.
- USB INPUT:** Connect audio source to send to Access Link. USB input can also be used for charging.

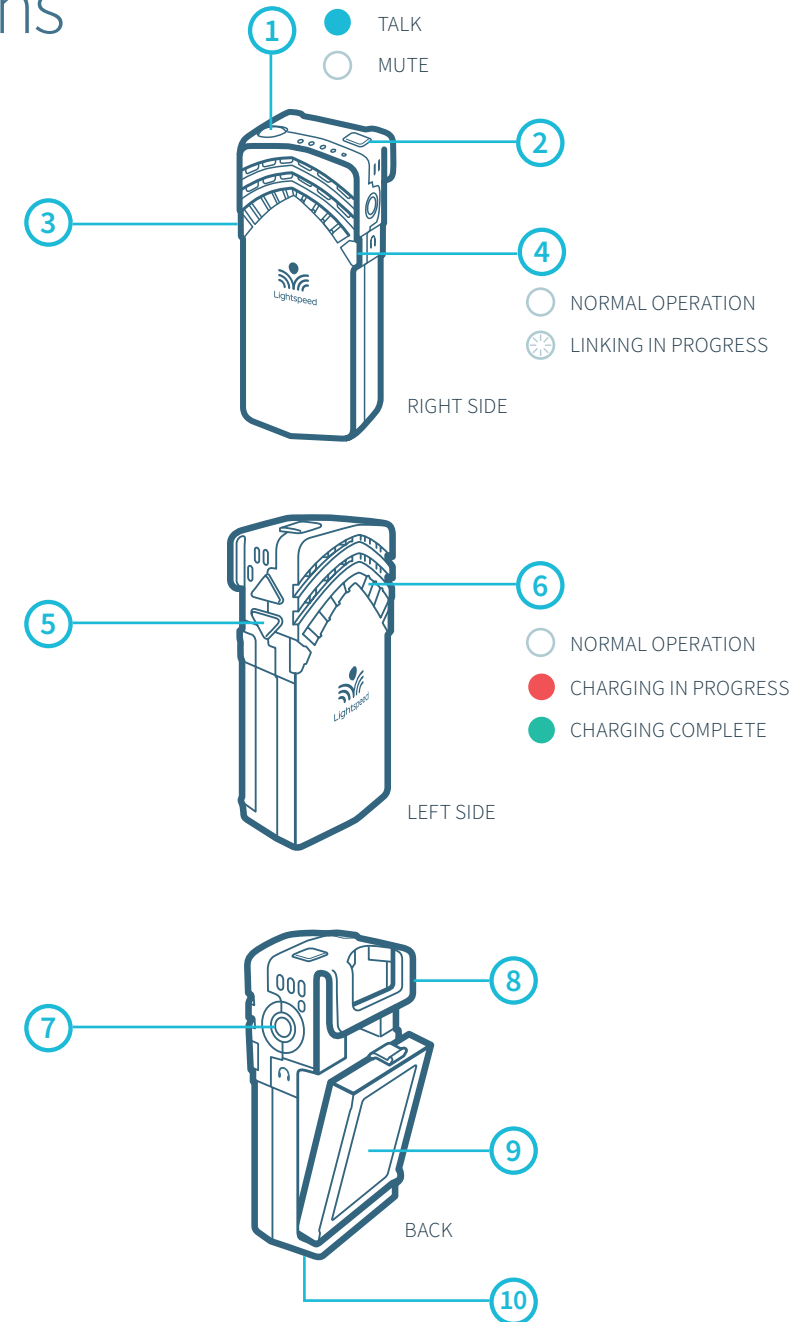





# Microphone Cradle Charger

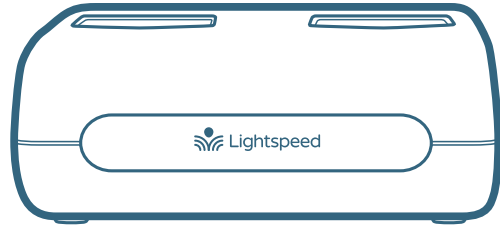

---

**DC POWER PORT:** Connect the 5V/1.0A DC power cord

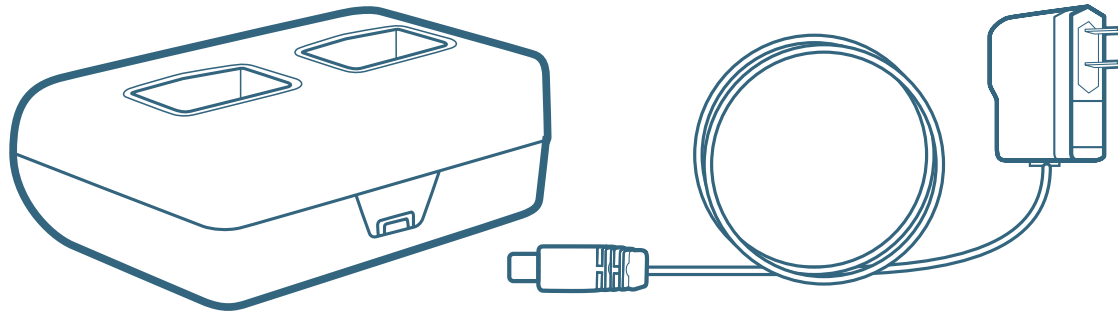



## SET-UP & OPERATION

# Determine Set-Up Location

Access Link is generally located near the amplifier. This minimizes the length of cable runs, reducing costs, labor and the possibility of unwanted EMI noise in the system.

If cable runs longer than 12 ft are required, we recommend using the balanced audio output with balanced audio cable.

**NOTE:** Do not install Access Link inside a fully enclosed metal cabinet or box. This will shield the box, cutting off all wireless transmission to and from the unit.

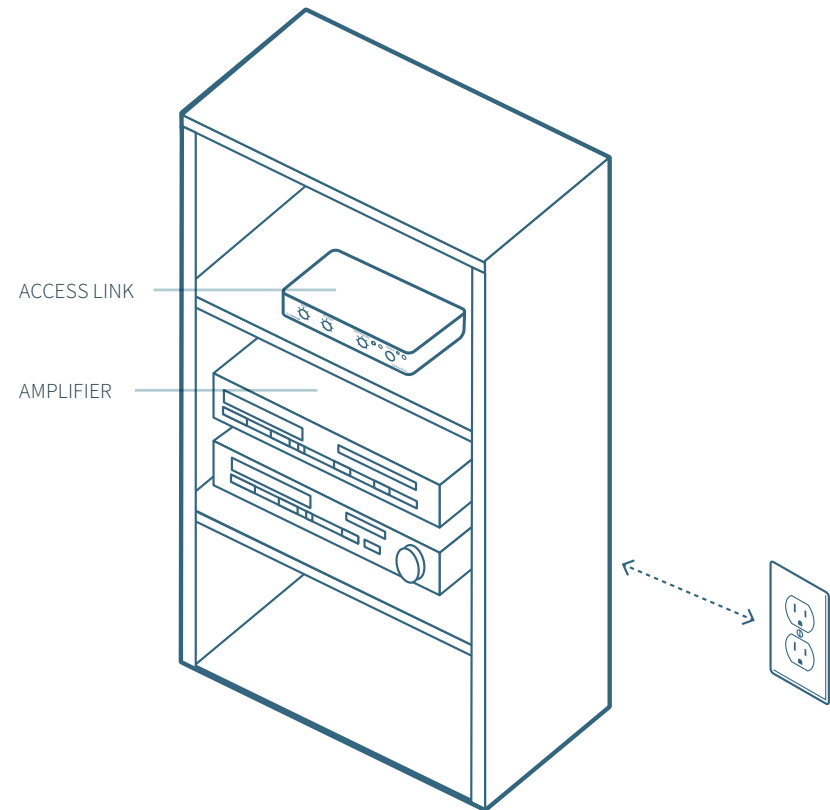



# Connect Access Link to Amplifier

## STANDARD UNBALANCED CONNECTION

1. Plug one end of the included 3.5mm cable into the AUDIO OUTPUT connection on Access Link.
2. Plug the other end into a microphone or audio input connection on an amplifier.  
**NOTE:** depending on the type of input jack on the amplifier, an adapter or other audio cable with matching plug may be required (not included).
3. Set the MIC/LINE level switch in the appropriate position. Generally LINE level is used unless the amplifier input is specifically marked as a "Microphone Input."

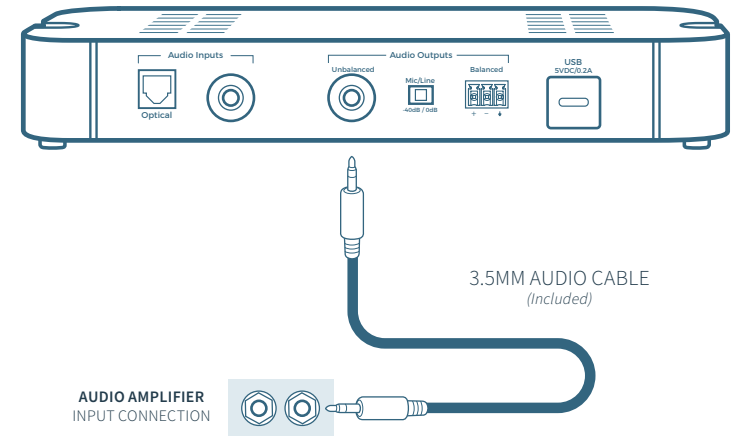

## BALANCED CONNECTION FOR LONGER CABLE RUNS

In the event Access Link must be located more than 12 feet away from the amplifier, it is recommended to use the balanced audio output on Access Link. To ensure a fully balanced connection, there must be a true balanced input on the amplifier and a balanced audio cable must be used.

1. Connect the stripped wires into the marked openings on the Euroblock connector:
  - A. Insert the positive and negative signal wires to the marked terminals.
  - B. Insert the shield to the ground terminal.
2. Secure the inserted wires by tightening the retaining screws.
3. Connect the other end of the cabling to a balanced input on the existing amplifier.

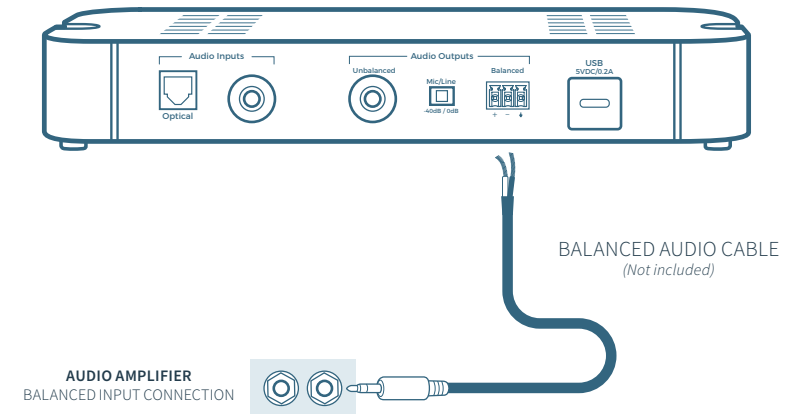



# Connect the Power Supply

Plug the USB end of the power adapter into the Access Link and the other side in an outlet. The white power light on the front of Access Link will light.

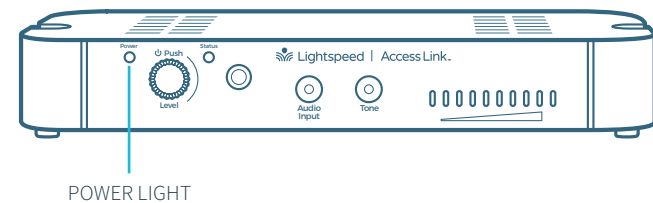
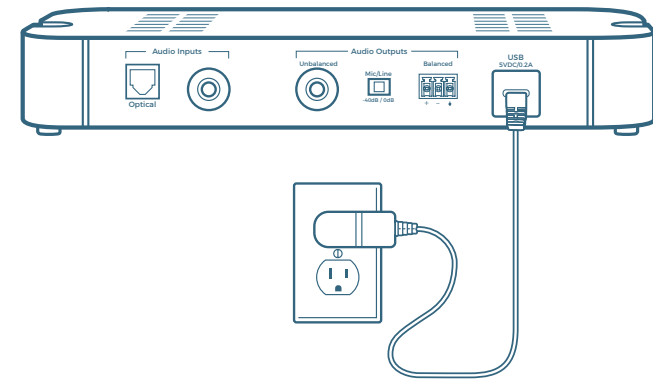



# Audio Integration

Various classroom multimedia audio sources would typically be connected directly into the audio amplifier to then be played through the classroom speakers. However, there is an additional 3.5mm audio input directly on Access Link. That audio is passed through Access Link and back out to the amplifier.

## AUDIO INPUT

Access Link has one AUDIO INPUT with volume control for connecting to classroom audio sources. Use a patch cable (not included) to connect a computer, cellular device, or other audio source.

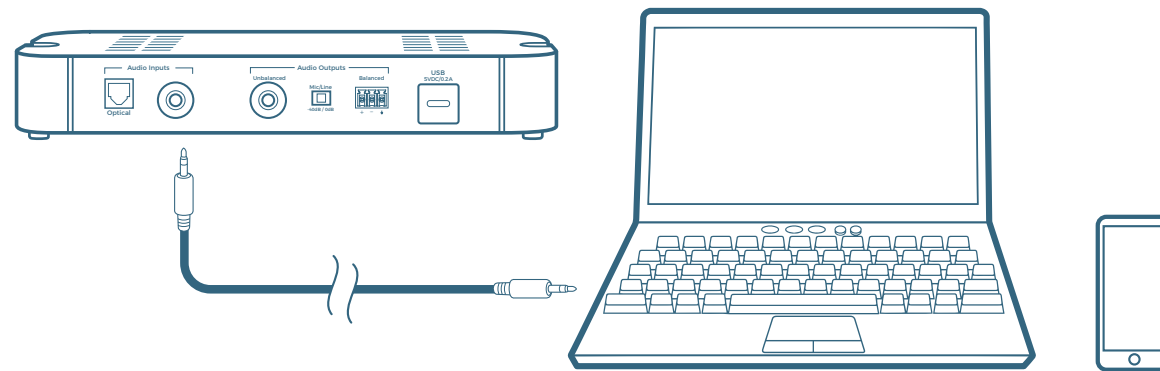



# Setting Up the Flexmike

Once the Flexmike is charged, follow these steps to set it up for use.

1. Remove the Flexmike from the cradle charger and put it on by connecting the magnetic clasps behind your neck. Adjust the lanyard so that the Flexmike is at the top of the collarbone.
2. The Flexmike will automatically power on and mute when it is removed from the charger. This will automatically power on Access Link as well.
3. The microphone volume on the Flexmike is set at the factory to the midpoint.
4. While speaking in a normal voice, fine-tune the microphone volume on the front of Access Link or down. Proper volume level should be as follows:
  - Your voice should be clearly heard by another person on the other side of the room.
  - You should barely be able to hear your own voice.
  - There should not be any audio “feedback” or squealing outside of 2-3 feet (if there is, turn the volume down slightly).

**REMEMBER:** This equipment supplements the user’s voice so they are able to speak in a conversational tone. Having the volume set too high will result in feedback and listener fatigue.

- Once initial volume level is set, walk around the room and listen for overall audio quality.
- If further fine-tuning is required, you may need to adjust the Tone Control on the front of the Access Link.
- If the Flexmike is out of range, it will automatically shut off after 30 minutes of trying to reconnect. Once you are back in the classroom, or in range, simply press and hold the power button on the Flexmike to power it up and resume normal operation.

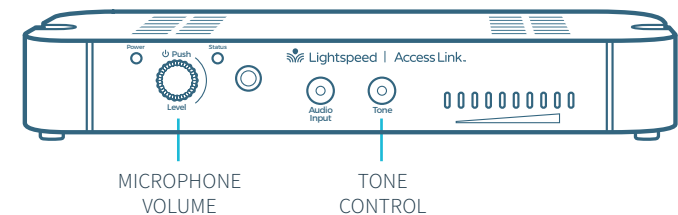
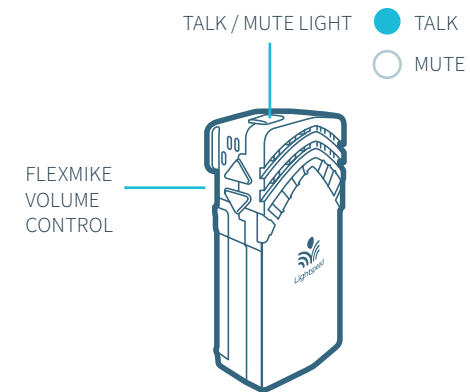
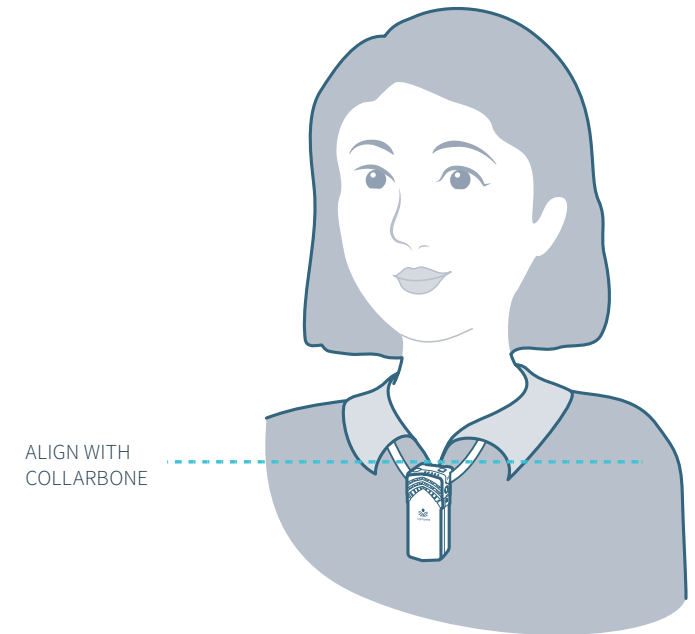



# Charging the Flexmike

## THE FLEXMIKE SHOULD BE CHARGED BEFORE USE

It will take 5-6 hours for the Flexmike to obtain a full charge. A fully charged Flexmike will last for up to 8 hours of use. If microphones are used daily, they should be charged each night.

Replacement lithium polymer battery packs may only be purchased through Lightspeed Technologies (part #L3.7V).

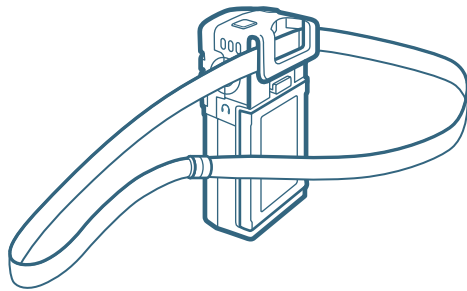

### ATTACH LANYARD

Hang the Flexmike on the lanyard opposite the magnetic clasp.

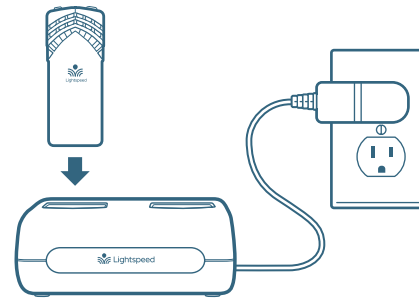

### CONNECT CRADLE CHARGER

Plug power cord into the cradle charger and then plug the AC end into an electrical outlet.

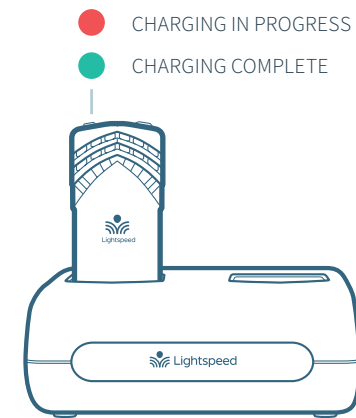

### CHARGE FLEXMIKE

Place the Flexmike into the cradle.

The LED on the Flexmike power light will glow red indicating charging has started.

It takes 5-6 hours to fully charge the Flexmike battery. When charging is complete, the power status light will glow green.



# Daily Use of the Flexmike

## 1. AT THE START OF THE DAY, REMOVE FLEXMIKE FROM THE CHARGER

- The microphone will default to the Mute position, the status light will turn to white.
- Place the microphone around your neck.
- Press the power/mute button. The light will turn blue, indicating the microphone is active and ready to use.
- Adjust volume with the UP/DOWN buttons if necessary.
- If Flexmike needs to be powered down for some time, press and hold the power button. To power Flexmike again, press and hold the power button until the blue light begins to blink.

## 2. PRIVATE CONVERSATIONS

- Mute the Flexmike during private conversations by momentarily pressing the power button. When muted, the blue light turns white.
- When conversation is over, momentarily press the power button again to unmute the Flexmike.

## 3. END OF DAY

- Place the Flexmike into the cradle charger and ensure the it is plugged in to an outlet.
- The Flexmike will stay powered on during charging, but will automatically be muted.
- it is not necessary to turn off the Access Link at the day but you may do so by pressing the power button on the front panel.
- If you do want to power it down, when Flexmike is removed from charging the next day, it will automatically power Access Link on.

POWER / MUTE BUTTON  
& STATUS LIGHT



VOLUME  
CONTROL

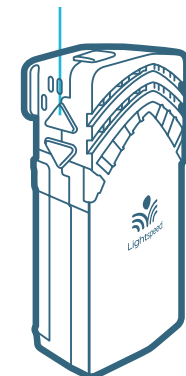





# Using Your Microphone as a Wireless Audio Link

You can connect your 2nd (or 3rd) microphone to your computer's USB port to enable a wireless 2-way audio link.

**SEND AUDIO FROM THE COMPUTER** to Access Link to ensure all audio from the computer (videos, video conferencing, audio books, music, etc) can be played through the Lightspeed Access Link system and speakers.

**SEND AUDIO TO THE COMPUTER** from Access Link to ensure the teacher's Flexmike and any student microphones are clearly picked up by a video conferencing solution.

1. With the appropriate USB cable (USB-C for Flexmike/Sharemike) connect your microphone to your computer's USB port. This will also power/charge your microphone.
2. Open sound settings on your computer:
  - Select Lightspeed Audio as the Output source to send all computer audio to Access Link.
  - Select Lightspeed Audio as the Input source to use the Lightspeed microphones as the computer microphone audio for video conferencing and recording applications.
3. You may also need to select Lightspeed Audio as the speaker and microphone audio in your video conferencing application the first time you use it.

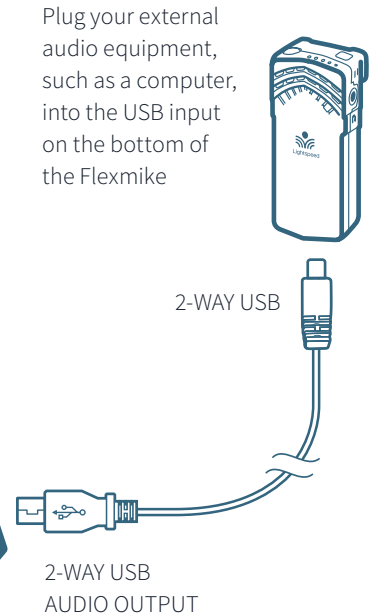
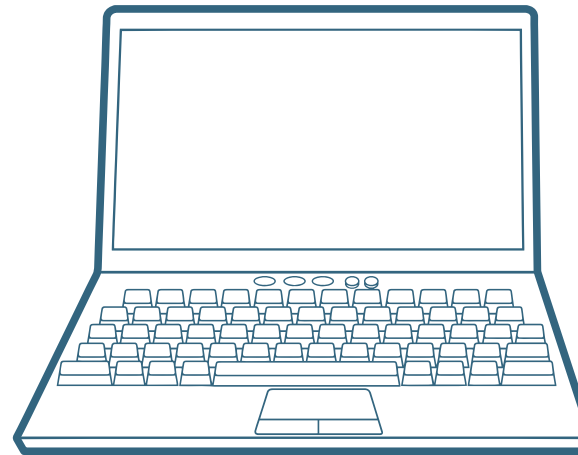

USB cable sold separately. Lightspeed offers a USB-A to USB-C cable for sale (part #USBC)



**TIP:** If your system includes two Flexmikes, you can use one mic for instruction and the second mic to transmit audio through the system.



## OPTIONAL ACCESSORIES

# ShareMike Controls and Connections

- POWER BUTTON**
- POWER STATUS LIGHT**  
**Red light:** During operation, turns red to indicate low battery  
**White light:** Normal operation  
  
When charging in Cradle Charger:  
**Red light:** Charging  
**Green light:** Charging complete
- MIC 1 STATUS:** Lighted to indicate microphone is registered as Mic 1  
**White: solid** = Normal operation  
**White: flashing** = Linking in process
- MIC 2 STATUS:** Lighted to indicate microphone is registered as Mic 2  
**White: solid** = Normal operation  
**White: flashing** = Linking in process
- MUTE/TALK STATUS LIGHT**  
**Blue: solid** = Talk  
**White: solid** = Mute
- MICROPHONE VOLUME UP/DOWN**
- USB INPUT:** Connect audio source to send to Access Link. USB input can also be used for charging.
- IR TRANSMITTER:** For pairing to base unit
- AUDIO INPUT:** Plug a laptop or other audio device into this jack to wirelessly transmit the audio signal to be played through the system
- VOLUME LOCK:** Disables volume controls

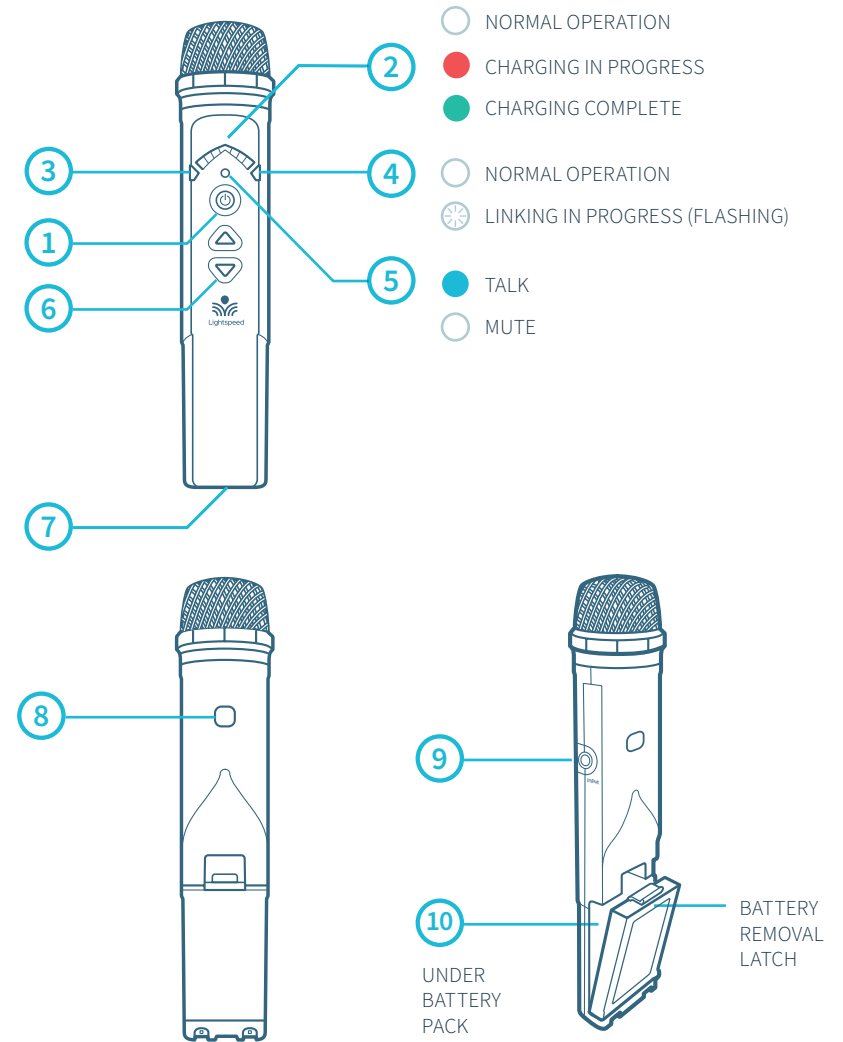



# ShareMike: Charging

1. Make sure the charger is plugged into a wall outlet.
2. The power status light on the microphone will glow red to indicate charging.
3. Leave the ShareMike in the charger overnight to obtain a full charge. It takes about 5-6 hours to fully charge the battery. The light will turn green when charging is complete.

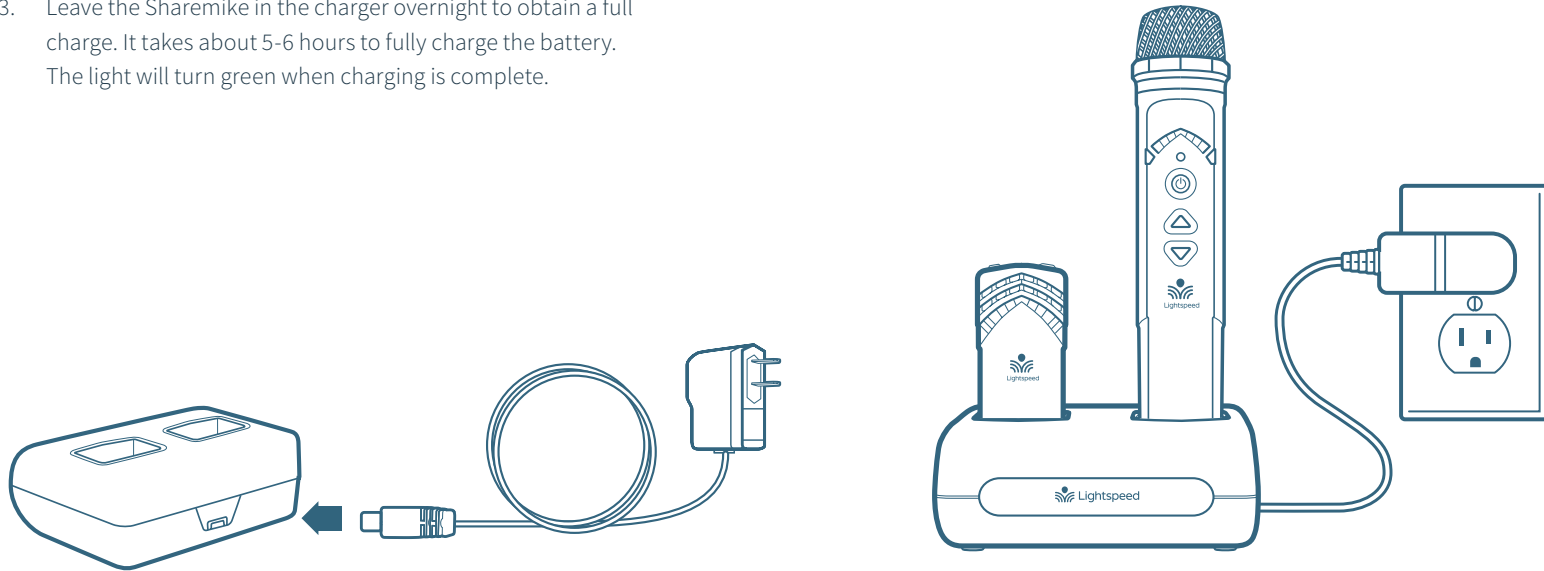

 **PLEASE NOTE:** Access Link and microphone(s) are paired together at the factory and all components should be kept together as a system. Moving them from one system, or room, to another will result in the need to re-pair.



# ShareMike: Initial Set-Up

1. Ensure the Access Link is on. The white power light will glow.
2. Turn on the ShareMike by pressing and holding the power button until the LED lights.
3. Grip the barrel in the center section.
4. While speaking in a normal voice, increase the volume with the ShareMike until your voice is barely audible.

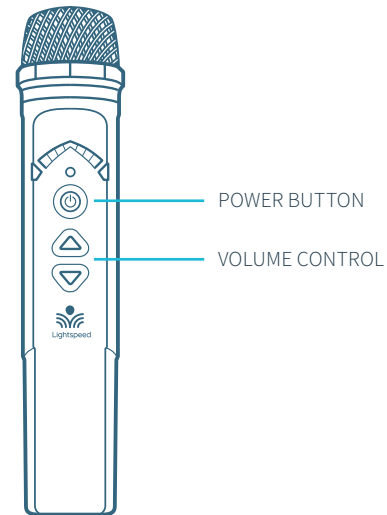
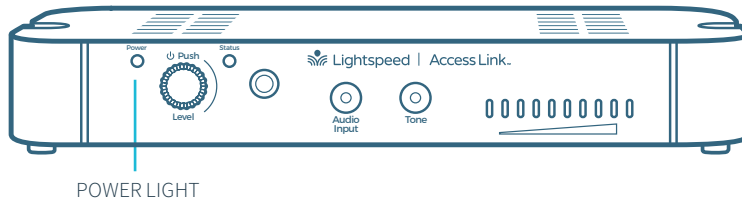

**PLEASE NOTE:** This equipment is designed to supplement and distribute the user's voice so they are able to speak in a conversational tone. Having the volume set too high will result in feedback and listener fatigue.



# Media Connector Controls and Indicators (Optional)

## FRONT PANEL

1. **POWER LIGHT**  
**White light:** Power on
2. **POWER BUTTON / VOLUME ADJUSTMENT:** Press this button to turn the system power on or off. This also functions as an adjustment knob for the volume and tone depending on the mode selected (see 4, 5, 6 below).
3. **STATUS LIGHT:** Microphone link and pair indicators.  
**Blue light:** Microphone(s) is paired to the system  
**Off:** Microphones are not paired to the system
4. **AUDIO INPUT VOLUME SELECTOR:** Selects Volume as the mode for the adjustment knob (2) for the audio sources connected to the audio inputs on the back of the Media Connector.
5. **AUDIO OUTPUT VOLUME SELECTOR:** Selects Volume as the mode for the adjustment knob (2) for the audio device connected to the audio output jack on the back of the Media Connector.
6. **tone SELECTOR:** Selects Tone as the mode for the adjustment knob (2) for the microphone. This adjusts the bass or treble that is heard through the classroom speaker.

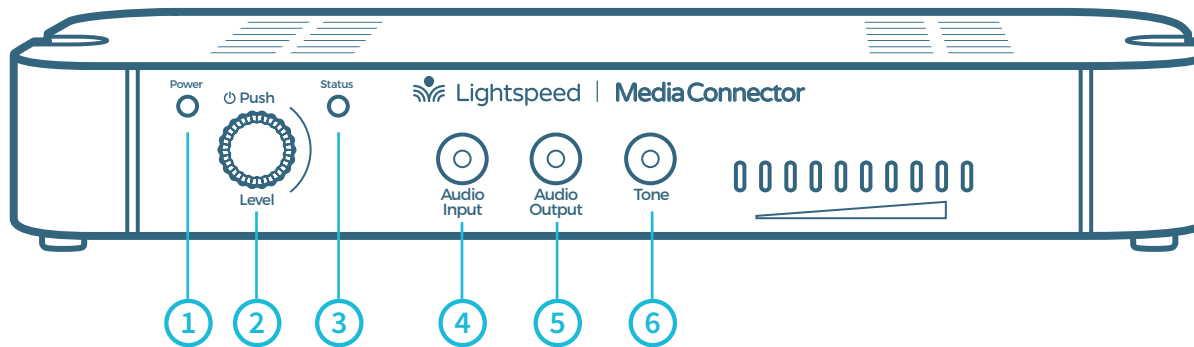



# Media Connector Controls and Indicators (Optional)

## BACK PANEL

1. **AUDIO INPUTS:** 3.5mm stereo connectors for connecting classroom audio sources to be played through audio system.
2. **AUDIO OUTPUTS:** 3.5mm stereo connectors for connecting to an assisted listening device (ALD) or to a computer for recording.
3. **USB INPUT:** Plug the USB-C end of the power cable into this USB port on the Media Connector.
  - The USB port supplies power to Media Connector when connected to the Media Connector power supply, or from a laptop.
  - It also acts as an input for a digital audio when connected to an audio source. Note that when the USB is used for audio input, the other four audio input jacks are not operational.

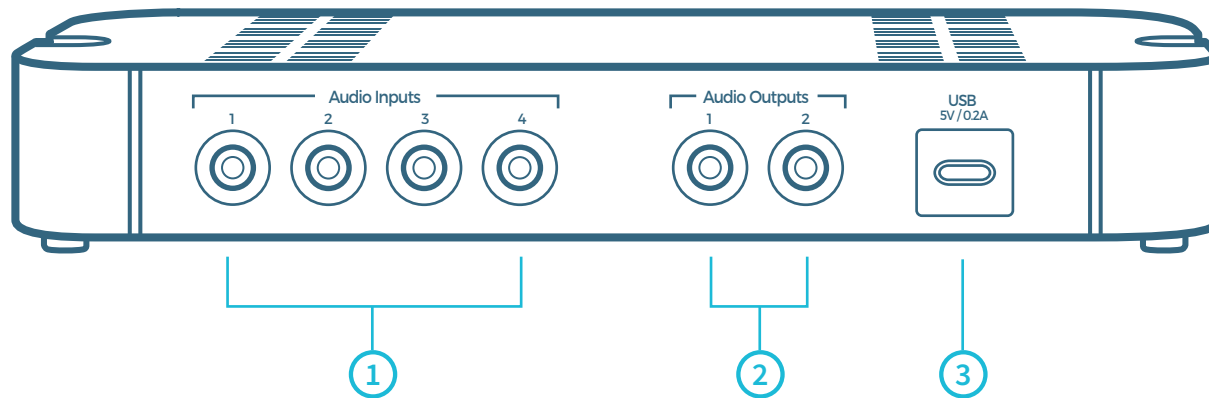



# Using the Media Connector

1. Plug the micro USB end of the power cable into the USB port on the back of the Media Connector. Plug the other end of the cable into the USB power adapter. Also, the USB cable could be plugged into a computer for power.
2. Connect the audio source(s) to the Media Connector using the 3.5mm cables provided.
3. Set the audio source volume to provide sound through Access Link.
4. Use the AUDIO IN volume control on the front of the Media Connector to increase or decrease the audio source sound level.

**NOTE:** The Media Connector can be used as the primary volume control for connected audio sources. When it is powered on and registered to Access Link, it locks out Master Volume and Tone controls on Access Link.

## USE THE MEDIA CONNECTOR AS THE MASTER AUDIO VOLUME CONTROL FOR OTHER AUDIO INPUT SOURCES

When two or more audio sources are connected, you will need to normalize volume settings by setting all connected audio sources to the same sound level while leaving the Media Connector AUDIO IN volume control set to its center setting. The Media Connector is an audio mixer using a master volume control to adjust the volume of all audio sources at once. Use the following procedure to set audio source volumes:

1. Connect the multimedia audio sources to the Media Connector using the 3.5mm cables provided.
2. Set the AUDIO IN volume control on the Media Connector to its center position.
3. Turn on an audio source that does not have an accessible audio level control (DVD, VCR player).
4. Adjust the Media Connector AUDIO IN volume control so the audio level playing through the speaker is appropriate for the classroom.
5. Turn off the first audio source.
6. Turn on the second audio source. Use its volume control to balance the audio output to the same audio level played through the speaker as the first source.
7. Repeat steps 5 and 6 for the remaining audio sources.
8. Now, the Media Connector's AUDIO IN volume can be used to increase or decrease the volume level for all audio sources as desired.

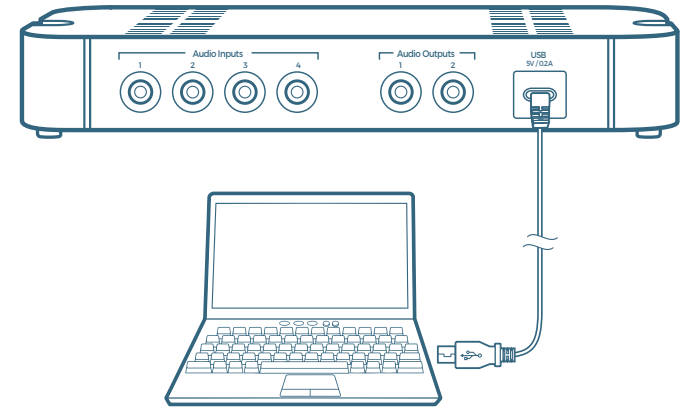



# Audio Integration with Media Connector

The Media Connector is designed to integrate multiple audio sources quickly and easily.

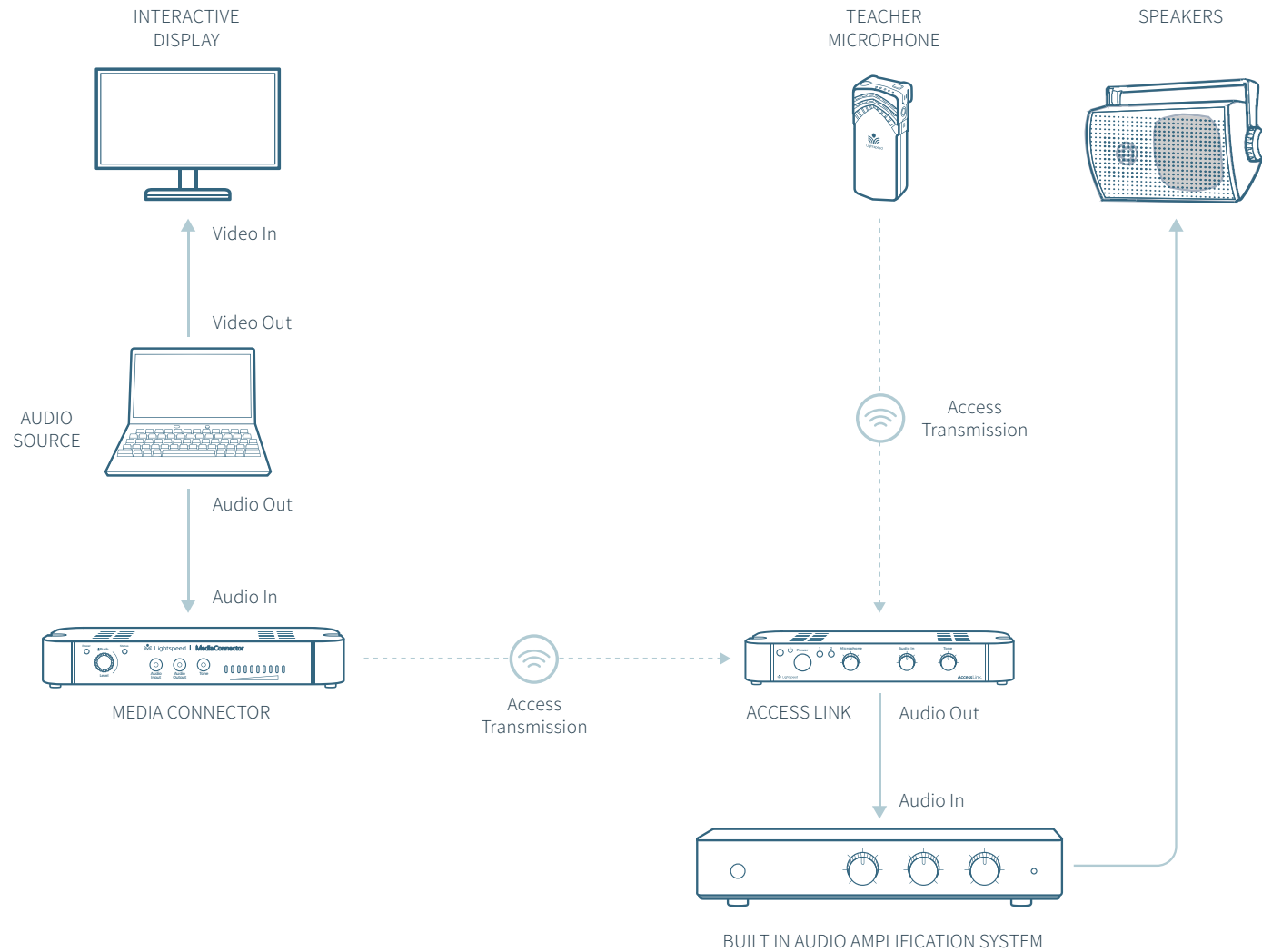

 LightSpeed Access transmission protocol





# Media Connector: Output to Assistive Listening Device (ALD)

1. Turn the AUDIO OUT volume control on the Media Connector front panel all way the down.
2. Determine the size and type of audio input jack on the device as many manufacturers' products differ in connector size and shape. Most personal FM transmitters require a 3.5mm to 3.5mm patch cable (part# MSC3535).
3. Connect a patch cable from the ALD's microphone jack or AUX input to the 3.5mm audio jack labeled "AUDIO OUT" on the back of the Media Connector.
4. With Access Link and ALD turned on, speak into the Flexmike and slowly adjust the AUDIO OUT volume control on the Media Connector until the appropriate audio level is attained in the ALD's receiver headphones.
5. It may be necessary to adjust the volume on the Personal FM receiver to achieve appropriate volume level.

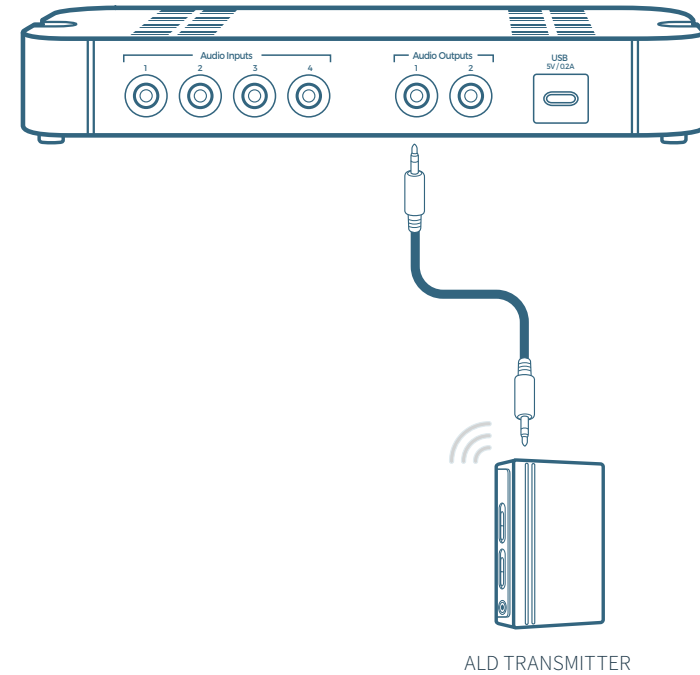



## MAINTENANCE & TROUBLESHOOTING

# Flexmike Battery Replacement

### Battery part #L3.7V

1. Push down on the latch and carefully pull the battery pack away from the Flexmike.
2. Insert new battery pack as shown and make sure the latch is secure.
3. Place the Flexmike in a cradle charger to charge the battery pack.

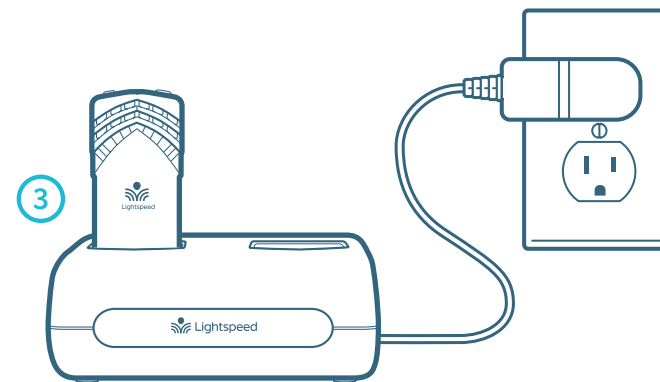
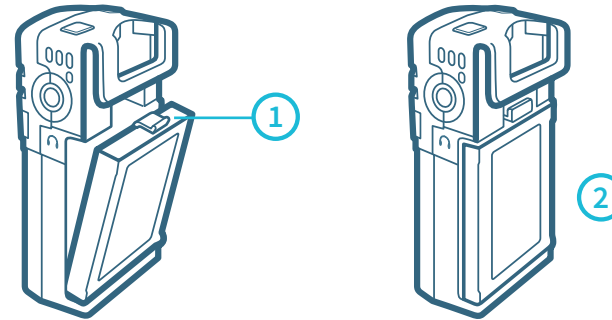



# ShareMike Battery Replacement

## Battery part # L3.7V

1. Push down on the latch and carefully pull the battery pack away from the ShareMike.
2. Insert new battery pack as shown and make sure the latch is secure.
3. Place the Flexmike in a cradle charger to charge the battery pack.

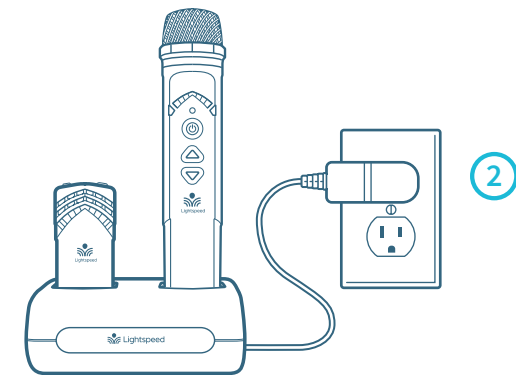
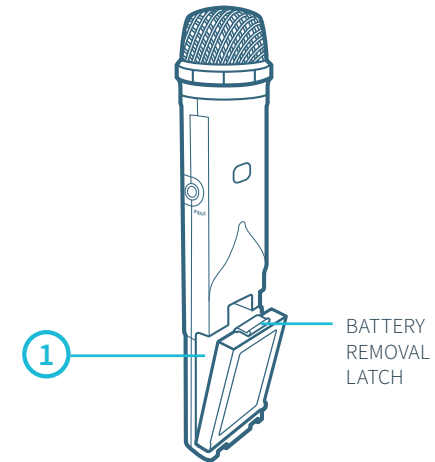



# Troubleshooting

**NOTE:** Most problems are directly related to low battery power. Please run through the “Battery Check” items first. For remaining troubleshooting, use known good, fully-charged batteries.

## BATTERY CHECK

- Confirm batteries are charged each night. A blinking red light on the power button indicates a low battery.
- Confirm proper batteries are used. The Flexmike requires the Lightspeed NH2.4V rechargeable battery pack. The Sharemike requires the Lightspeed BA-NH2APK rechargeable battery pack.
- Make sure the microphones obtain a full charge. A full charge takes 8-9 hours.
- When charging a transmitter, ensure the blue status light and the red charging light turn on. The green light will turn on when a full charge is reached.

**PROBLEM:** Microphone doesn’t indicate a “Ready” signal (solid blue or red light)

**SOLUTION:** Follow these steps to ensure the system is ready to use.

- Ensure the power button on the microphone is turned on. Once turned on, the blue light should begin blinking.
- Power the microphone off, then on again after a few seconds. Wait for up to 30 seconds for the blue light to turn solid, indicating READY for operation.

**PROBLEM:** Low Volume or Feedback

**SOLUTION:** Follow these steps to eliminate low volume or feedback.

- Check microphone volume level on Access Link. If the volume is too high, feedback will occur. Adjust accordingly.
- Check input volume level on the amplifier. If the volume is too high, feedback will occur. Adjust accordingly.
- Adjust the volume level on the Flexmike.
- Check position of the Mic-Line switch on Access Link. If volume levels seem too high and feedback is persistent, try the Mic level setting. If volume levels are very low, try the Line level setting.

**PROBLEM:** No Sound From Access Link and wireless components.

**SOLUTION:** Follow these steps to produce sound from Access Link.

- Confirm that the blue POWER light located on the front panel of Access Link is on.
- Confirm the microphone is powered on and linked to Access Link. The mic 1 status light will be green on Access Link indicating the microphone is linked.
- Confirm that the microphone is turned on. There will be a solid blue light on the top of microphone to indicate it is powered on and ready.

- Confirm that microphone is not muted. A solid red light on the top of microphone will indicate it is muted.
- Check connections between Access Link and the amplifier. Make sure the cables are properly connected (see page 12 for more information).
- Check volume level of Access Link. Make sure that the microphone volume level on Access Link is not turned down all the way. Slowly turn up the volume level while talking in the microphone.
- Check volume level on the appropriate amplifier control. Make sure that volume level that corresponds with the input connection is turned up to a nominal level.
- Check the position of the Mic-Line switch. If it is set to Mic level, try switching it to Line level.

**PROBLEM:** Activate app shows message “Activate Station is out of range or has no power”:

**SOLUTION:**

- This indicates the Bluetooth signal between your device and the Activate Station are having trouble communicating, usually due to range between the mobile device and the Activate Station.
- Make sure your mobile device is within 50-100 feet of the Activate Station. Walk up to the Activate and wait several seconds for the app to reconnect.
- If it does not automatically reconnect, try force quitting the app: for iOS, double tap the Home button on your iOS device, then swipe up the Activate app to close it. For Android, launch the Recent Applications menu, scroll to find the Activate app, then swipe the app to the right to quit. Re-open the app and it should connect automatically.

**PROBLEM:** Activate app shows “No Response from the Classroom Audio System”

**SOLUTION:**

- This indicates the app is not communicating with the Access amplifier, usually due to loss of communication between the Activate and the amplifier.
- Make sure the Access amplifier is plugged into power and is powered on.
- If it does not automatically reconnect when the amplifier is powered on, try force quitting the app: for iOS, double tap the Home button on your iOS device, then swipe up the Activate app to close it. For Android, launch the Recent Applications menu, scroll to find the Activate app, then swipe the app to the right to quit. Re-open the app and it should connect automatically.

**PROBLEM:** Software update is needed

**SOLUTION:** Go to <https://app.tara.lightspeed-tek.com/> and follow the steps.

- For a step by step video tutorial please visit <https://www.youtube.com/watch?v=dGnhziACJ9c>

**If you review these instructions and still have questions, call Lightspeed Technical Services at 800.732.8999, 5am – 5pm, PST. Customers outside the U.S. should contact their local reseller.**



## WARRANTY, SAFETY & SPECIFICATIONS

### Five-Year Limited Warranty

Lightspeed Classroom Audio Systems are guaranteed against malfunction due to defects in materials and workmanship for a period of five (5) years, beginning at the date of the purchase invoice. If such malfunction occurs, the product will be repaired or replaced (at Lightspeed's option) without charge during the warranty period.

Lightspeed's Warranty Exchange Program applies to all classroom audio systems within the five (5) year warranty period. If a classroom audio product or component has an issue that requires service, a refurbished replacement will immediately be sent to the customer to minimize downtime. Customers will receive the exchange product(s) or component(s) within 2-3 days. A prepaid return label will be included with exchanged products so original malfunctioned equipment can be returned to Lightspeed. Any exchanged equipment will remain covered under the original five-year warranty.

1. Warranty on transceivers is five (5) years.
2. Warranty on Lightspeed NiMH and Lithium Polymer rechargeable batteries is one (1) year.
3. A prepaid shipping label will be provided by Lightspeed for warranty repairs within the United States. Customers outside the U.S. should refer to the Lightspeed website ([www.lightspeed-tek.com](http://www.lightspeed-tek.com)) for warranty repair instructions.
4. Warranty does not extend to finish, appearance items, or malfunctions due to abuse or operation other than specified conditions, nor does it extend to incidental or consequential damages. Repair by other than Lightspeed or its authorized service agencies will void this warranty. Information on authorized service agencies is available from Lightspeed Technologies, Inc.

**Our Service Department (800.732.8999, 5am–5pm, PST) will handle your repair or replacement needs.**

Customers outside the U.S. should contact their local reseller.



# Safety Warnings and Certifications



**CAUTION**

**RISK OF ELECTRICAL SHOCK**

**DO NOT OPEN**



**THIS PRODUCT MUST BE INSTALLED IN ACCORDANCE WITH THE APPLICABLE INSTALLATION CODE BY A PERSON FAMILIAR WITH THE CONSTRUCTION AND OPERATION OF THE PRODUCT AND THE HAZARDS INVOLVED.**



**The lightning flash** with arrowhead symbol inside an equilateral triangle is intended to alert the user to the presence of non insulated “hazardous voltage” within the product’s enclosure, which may be of sufficient magnitude to induce a risk of electric shock to persons.



**The exclamation mark** inside an equilateral triangle is intended to alert the user to the presence of important operating and maintenance (servicing) instruction in the literature accompanying this product.



**USE A LIGHTSPEED SUPPLIED BATTERY ONLY**



CAUTION: Risk of explosion if battery is replaced by an incorrect type. Dispose of used batteries according to the instructions.



Battery subjected to extremely low air pressure that may result in an explosion or the leakage of flammable liquid or gas.

## CERTIFICATIONS



This product is listed to UL standards and requirements for electrical safety by Underwriters Laboratories Inc.



This product conforms with the essential requirements of the following European Union Directives: 2004/108/EC Electromagnetic Compatibility (EMC) and 2006/95/EC Low Voltage Directive (LVD).



LightSpeed Technologies launched a formal product recycle program in Europe that complies with the European Union Directive 2002/96/EC on Waste Electrical and Electronic Equipment (“WEEE Directive”). Please visit [www.light-speed-tek.com](http://www.light-speed-tek.com) for more information.



This product is manufactured using lead-free processes and is free of other materials harmful to the environment. It conforms to the most stringent new European guidelines for consumer products (RoHS).



# Précautions De Sécurité et Certifications



**ATTENTION**

**RISQUE D'ÉLECTROCUTION  
NE PAS OUVRIR**



**CONFORMÉMENT AUX NORMES D'INSTALLATION APPLICABLES, CE PRODUIT DOIT ÊTRE INSTALLÉ PAR UNE PERSONNE FAMILIARISÉE AVEC LA CONCEPTION ET LE FONCTIONNEMENT DU PRODUIT ET CONSCIENTE DES RISQUE ENCOURUS.**



**L'éclair flèche** dans un triangle équilatéral avertit l'utilisateur de la présence d'une "tension dangereuse" non isolée à l'intérieur de l'appareil, qui peut être d'une ampleur suffisante pour constituer un risque d'électrocution.



**Le point d'exclamation** contenu dans un triangle équilatéral avertit l'utilisateur de la présence d'importantes instructions d'exploitation et de maintenance dans la documentation qui accompagne ce produit.



UTILISEZ UNIQUEMENT LA BATTERIE LIGHTSPEED FOURNIE



ATTENTION: Risque d'explosion si la batterie est remplacée par un type incorrect. Mettre au rebut les batteries usagées selon les instructions.

## CERTIFICATIONS



Ce produit est certifié conforme aux normes et aux exigences UL en matière de sécurité électrique par Underwriters Laboratories Inc.



Ce produit est conforme aux principales exigences des directives de l'Union Européenne suivantes : 2004/108/EC Electromagnetic Compatibility (EMC) and 2006/95/EC Low Voltage Directive (LVD).



Lightspeed Technologies a lancé un programme de recyclage de produits en Europe conformément à la directive de l'Union Européenne 2002/96/CE relative aux déchets d'équipements électriques et électroniques (directive « DEEE »). Veuillez visiter notre page Web [www.Lightspeed-tek.com](http://www.Lightspeed-tek.com) pour plus de renseignements.



Ce produit est fabriqué en utilisant des processus sans plomb ni aucune autre matière nuisible à l'environnement. Il est conforme aux nouvelles règles européennes les plus strictes en matière de biens de consommation (RoHS).



# FCC Notice to user

This device complies with Part 15 of the FCC Rules. Operation is subject to the following two conditions:

1. This device may not cause harmful interference; and
2. This device must accept any interference received, including interference that may cause undesired operation.

This equipment has been tested and found to comply with the limits for a Class B digital device, pursuant to Part 15 of the FCC Rules. These limits are designed to provide reasonable protection against harmful interference in a residential installation.

This equipment generates, uses, and can radiate radio frequency energy and, if not installed and used in accordance with the instructions, may cause harmful interference to radio communications. However, there is no guarantee that interference will not occur in a particular installation.

If this equipment does cause harmful interference to radio or television reception, which can be determined by turning the equipment off and on, the user is encouraged to try to correct the interference by one or more of the following measures:

- Reorient or relocate the receiving antenna (that is, the antenna for radio or television that is receiving” the interference).
- Reorient or relocate and increase the separation between the telecommunications equipment and receiving antenna.
- Connect the telecommunications equipment into an outlet on a circuit different from that to which the receiving antenna is connected.
- Consult the dealer or an experienced radio/TV technician for help.

## English

**IMPORTANT NOTE:** To comply with the FCC RF exposure compliance requirements, the antenna(s) used for this transmitter must be installed to provide a separation distance of at least 20 cm from all persons and must not be co-located or operating in conjunction with any other antenna or transmitter. No change to the antenna or the device is permitted. Any change to the antenna or the device could result in the device exceeding the RF exposure requirements and void user’s authority to operate the device.

## French

**NOTE IMPORTANTE:** Pour se conformer aux règles d’exposition des ondes RF par la FCC, la (ou les) antenne(s) utilisée(s) par ce transmetteur doivent être installées de façon à être séparée d’une distance d’au moins 20 cm de toute personne et ne doit pas être utilisée près ou en conjonction avec aucune autre antenne ou transmetteur. Aucune modification à l’antenne ou à l’appareil n’est permise. Toute modification à l’antenne ou à l’appareil peut résulter que l’appareil excèdera l’exposition aux ondes RF réglementaires et ainsi annuler le droit à l’usager d’utiliser l’appareil.

## FCC RF Radiation Exposure Statement

This device (Access Link) complies with the FCC RF radiation exposure limits set forth for an uncontrolled environment. This device should be installed and operated with a minimum distance of 20cm between the radiator (Access Link) and any part of your body.

For body worn operation, the portable part (Flexmike) has been tested and meets FCC RF exposure guidelines.

This device must not be co-located or operating in conjunction with any other antenna or transmitter. The changes or modifications not expressly approved by the party responsible for compliance could void the user’s authority to operate the equipment.

## Notice to Canada User

### English

This device complies with Industry Canada license exempt RSS standard(s).

Operation is subject to the following two conditions:

1. This device may not cause interference, and
2. This device must accept any interference, including interference that may cause undesired operation of the device.

### French

Le présent appareil est conforme aux CNR d’Industrie Canada applicables aux appareils radio exempts de licence.

1. L’exploitation est autorisée aux deux conditions suivantes :
2. L’appareil ne doit pas produire de brouillage, et l’utilisateur de l’appareil doit accepter tout brouillage radioélectrique subi, même si le brouillage est susceptible d’en compromettre le fonctionnement.





# EU Declaration of Conformity

According to EU Directives EMC 2014/30/EU, LVD 2014/35/EU, RED 2014/53/EU, RoHS 2011/65/EU

**Manufacturer:** Lightspeed Technologies, Inc.

**Address:** 11509 SW Herman Rd.  
Tualatin, Oregon 97062

*We herewith declare that the following systems comply with the appropriate basic safety and health requirements of the Directive based on its design and type, as brought into circulation by us. In case of alteration of the system, not agreed upon by us, this declaration will lose its validity.*

**Products:** Redcat, Topcat, 975, Access Link, Flexmike, Sharemike, Pod, Activate Station, Media Connector, Mobile PA

**Model Numbers:** RCN, TCN, 975, ALN, FMN, SMN, POD, ACT, MCN, MPA

As applicable, products conform to the standards listed below:

EN 62368-1:2014

IEC 62133:2012

EN 50385:2017

EN 50566:2017

EN 50663:2017

EN 62479:2010

ETSI EN 301 406 V2.2.2 (2016-09)

ETSI EN 301 489-1 V2.2.3 (2019-11)

ETSI EN 301 489-6 V2.2.1 (2019-04)

EN IEC 63000:2018

The Technical Construction File is available to proper authorities and the product is CE marked.

Lightspeed Representative

Date: December 6, 2022

Michael Frost, Compliance Engineer



# System Specifications

## ACCESS LINK

<b>Description</b>	Wireless audio base station
<b>Audio output level (Nominal)</b>	Line Mode: 316 mV RMS (2V RMS max) Mic Mode: -40 dB of line mode
<b>Frequency response</b>	120 Hz - 8 kHz
<b>DC power Input</b>	5V/250mA USB-C connector
<b>Total harmonic distortion</b>	<1% @ 10W
<b>Wireless communication</b>	Access Technology (1.9 GHz)
<b>Tone control</b>	1 bass/treble control
<b>Audio input</b>	3.5mm stereo and optical input
<b>Audio outputs</b>	3.5mm stereo; 3-pin balanced Euroblock with volume control
<b>Audio Link indicator</b>	1 LED to indicate microphone is linked
<b>Device registration</b>	Push button for pod(s), Flexmike(s), Sharemike, Media Connector
<b>Dimensions (W x H x D)</b>	7.6" x 5" x 1.13" (193 x 127 x 29mm)
<b>Weight</b>	9.6 oz. (272g)

## FLEXMIKE (1-2)

<b>Description</b>	Pendant-style transceiver
<b>Earbud lanyard</b>	Magnetic clasp with integrated earbud
<b>Wireless communication</b>	Access Technology (1.9 GHz)
<b>Audio distortion</b>	<1%
<b>Integrated microphone</b>	Uni-directional electret
<b>Earbud output</b>	3.5mm
<b>Audio input</b>	USB-C
<b>Volume control</b>	+/- 6 dB
<b>Battery power</b>	3.7V LiPo battery pack
<b>Battery life</b>	8 hours (fully charged)
<b>Charging</b>	2 contacts for cradle charging

<b>USB connection</b>	Type C for charging and audio
<b>Power</b>	On/off switch
<b>Registration</b>	Push button for registration with Access Link
<b>Dimensions (L x W x H)</b>	2.9" x 1.1" x 0.7" (74 x 28 x 18mm)
<b>Weight</b>	1.2 oz (34g)

## SHAREMIKE

<b>Description</b>	Handheld transceiver
<b>Wireless communication</b>	Access Technology (1.9 GHz)
<b>Audio distortion</b>	<1%
<b>Integrated microphone</b>	Uni-directional electret
<b>Audio input</b>	3.5mm
<b>Battery power</b>	3.7V LiPo battery pack
<b>Battery life</b>	8 hours (fully charged)
<b>Charging</b>	2 contacts for cradle charging
<b>Power</b>	On/off button
<b>Registration</b>	Push button for registration with Access Link
<b>Dimensions (L x W x H)</b>	6.0" x 1.1" x 1.1" (153 x 28 x 28mm)
<b>Weight</b>	2.6 oz (73g)

## MEDIA CONNECTOR

<b>Description</b>	Wireless audio transceiver
<b>USB power</b>	5V USB-C connector
<b>Wireless communication</b>	Access Technology (1.9 GHz)
<b>Tone control</b>	1 bass/treble control
<b>Audio input</b>	3.5mm stereo (x4) with master volume
<b>Audio output</b>	3.5mm stereo (X2) mixed with volume control
<b>Audio Link indicator</b>	1 LED on front panel
<b>Device registration</b>	Push button for Access Link
<b>Dimensions (W x H x D)</b>	7.6" x 5" x 1.13" (193 x 127 x 29mm)
<b>Weight</b>	9.6 oz. (272g)



## Dedicated to Access for All

We strive to make a remarkable difference for teachers and students by creating Access to powerful in-the-moment insights to the learning process. Our audio and video solutions improve student engagement, enable teachers to activate small groups, and encourage collaboration.

11509 SW Herman Road  
Tualatin, Oregon 97062  
Toll Free: 800.732.8999  
Phone: 503.684.5538  
Fax: 503.684.3197  
[lightspeed-tek.com](http://lightspeed-tek.com)